

JET-SURFACE VENTILATOR TYPES



SMOKEJET®, SMOKEJET® D, SMOKEJET® R and SMOKEJET® RD



Installation possibilities

depending on JET-surface ventilator type

- in flat roof
- in thermal/ISO roofs
- in JET-VARIO-NORM continuous rooflight
- in JET-VARIO-THERM continuous rooflight
- in JET-VARIO-THERM S continuous rooflight
- in glass roof (vertical rod-interlock constructions)
- in shed glazings (system Prokuwa/Rodeca)
- in wired glass (renovation)
- installation in the wall (e.g. as air intake for SHEV systems)

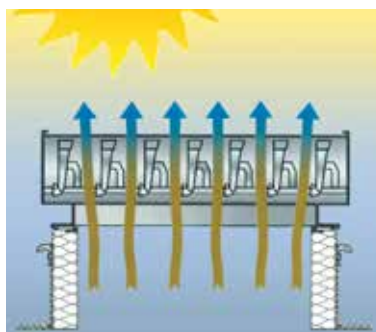

functions SMOKEJET®/SMOKEJET® D:
fair weather ventilation and SHEV systems



JET-SMOKEJET® surface ventilator
installed in the facade for ventilation,
SHEV-air intake and daylight



functions SMOKEJET® R/SMOKEJET® RD:
fair weather, rain-proof ventilation and
SHEV systems illustration of ventilation
in case of rain



SMOKEJET® and SMOKEJET® D

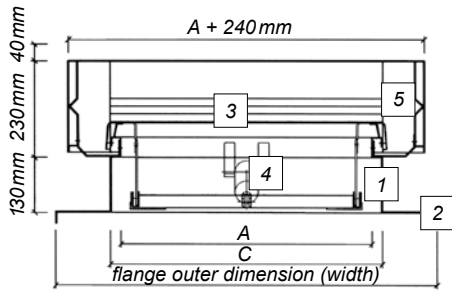

cross section

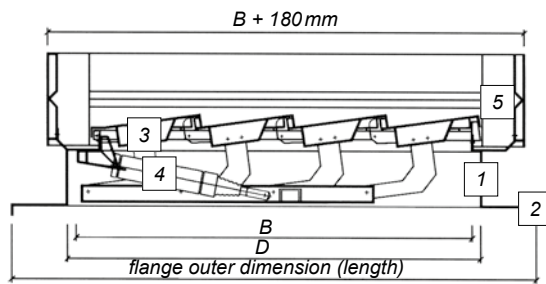

longitudinal section

SMOKEJET® R and SMOKEJET® RD

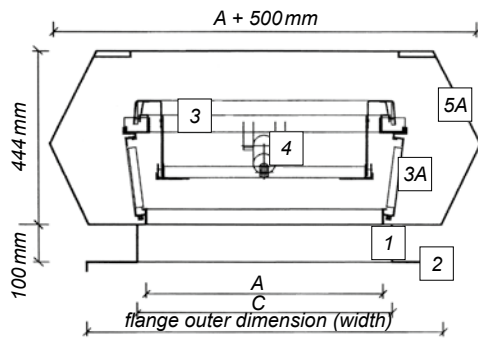

cross section

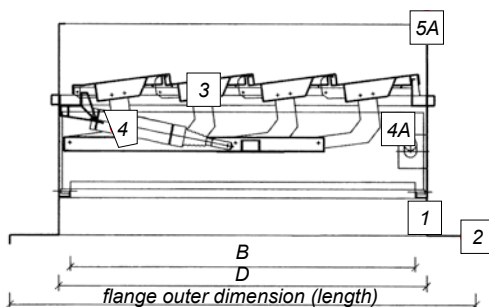











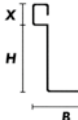
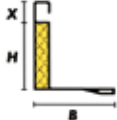





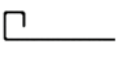
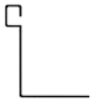

longitudinal section

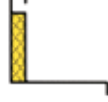
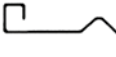
- 1 Unit base
 - aluminium construction available in 3 versions
 - low base uninsulated
 - high base uninsulated
 - high base insulated
 - 2 Unit flange
 - aluminium construction with and without insulation
 - F1 = e.g. for one wired glass
 - F2 = e.g. for insulation glass
 - F3 = e.g. for corrugated sheets
 - F4 = e.g. for wall installation
 - F5 = e.g. for upstand
 - F6 = e.g. for profiled roof
 - F7 = e.g. for continuous rooflight (head piece)
 - A combination of different flange types is possible.
 - 3 Lamellar
 - 1-shelled aluminium lamellar uninsulated
 - 2-shelled aluminium lamellar insulated
 - PC-16 lamellar in opal or clear
 - insulation glass (LSG 3.3.1)
 - 3A Side lamellar
 - for rain-proof ventilation
 - available in 200 and 300 mm height
 - 1-shelled aluminium lamellar uninsulated
 - 2-shelled aluminium lamellar insulated
 - 4 Operation
 - pneumatic cylinder in single and double pipe system (also in DIN-version)
 - 24 volt motor opener (also in DIN-version)
 - 230 volt motor opener
 - 4A Operation of the side lamellar
 - pneumatic cylinder
 - 24 volt motor opener
 - 230 volt motor opener
 - 5 Wind baffles
 - aluminium construction
 - (only necessary in case of DIN-version)
 - 5A Fan housing
 - aluminium construction with especially aerodynamic shape for the intake of the side lamellar 3A, at the same time serves also as wind baffle
- additional equipment
- insect protection grid
 - bird protection grid
 - coating in RAL

JET-surface ventilator
 SMOKEJET®, SMOKEJET® D, SMOKEJET® R,
 SMOKEJET® RD

Unit base and flange design – variable in the width –
 also suitable for your opening in the building

1 2 type of flange	base	low base	high base	high base, heat insulated
		X = integrated in fan housing B = individual (standard 130 mm)	X = integrated in fan housing H = 130 mm H = 100 mm, for types R and RD B = individual (standard 130 mm)	X = integrated in fan housing H = 130 mm H = 100 mm, for type R and RD B = individual (standard 130 mm)
F1				
F2		1)		
F3				
F4		1)		
F5		1)		
F6				
F7				

1) flange design optional also insulated

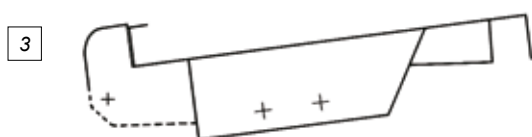

1-shelled aluminium lamellar uninsulated



2-shelled aluminium lamellar insulated

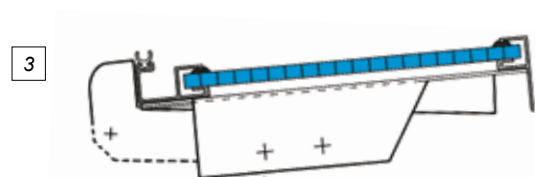

PC-16 polycarbonate triple-skin sheet clear or opal

NOTE:

In case of OPEN-operation of the side lamellar e.g. via a rain detector the surface lamellar are closed automatically. The SHEV-emergency control remains as priority in every case.

SIZE OVERVIEW

width in cm quantity lamellar	base with heat insulation		weight with polycarbonate glazing		low base without/ high base with heat insulation	high base without heat insulation
	A _v -value acc. DIN EN 12101-2	geom. effective ventilation surface of the surface lamellar	SMOKEJET® SMOKEJET® D	SMOKEJET® R SMOKEJET® RD	width x length in mm	width x length in mm
	m²	m²	approx. kg	approx. kg	A x B in mm	C x D in mm
60 / 4	0,3384	0,496	23	40	600 x 940	640 x 980
60 / 5	0,4176	0,612	27	44	600 x 1160	640 x 1200
60 / 6	0,4968	0,729	30	49	600 x 1380	640 x 1420
60 / 7	0,5760	0,845	33	53	600 x 1600	640 x 1640
60 / 8	0,6552	0,961	36	58	600 x 1820	640 x 1860
60 / 9	0,7344	1,077	39	62	600 x 2040	640 x 2080
60 / 10	0,8136	1,193	42	67	600 x 2260	640 x 2300
60 / 11	0,8928	1,309	45	71	600 x 2480	640 x 2520
60 / 12	0,9720	1,426	48	76	600 x 2700	640 x 2740
60 / 13	1,0512	1,542	51	80	600 x 2920	640 x 2960
120 / 4	0,6768	0,993	33	57	1200 x 940	1240 x 980
120 / 5	0,8352	1,225	38	64	1200 x 1160	1240 x 1200
120 / 6	0,9936	1,457	42	70	1200 x 1380	1240 x 1420
120 / 7	1,1520	1,690	47	77	1200 x 1600	1240 x 1640
120 / 8	1,3104	1,922	51	83	1200 x 1820	1240 x 1860
120 / 9	1,4688	2,154	56	90	1200 x 2040	1240 x 2080
120 / 10	1,6543	2,387	60	96	1200 x 2260	1240 x 2300
120 / 11	1,8153	2,619	65	103	1200 x 2480	1240 x 2520
120 / 12	1,9440	2,851	69	109	1200 x 2700	1240 x 2740
120 / 13	2,1024	3,084	74	116	1200 x 2920	1240 x 2960
180 / 4	1,0152	1,489	42	75	1800 x 940	1840 x 980
180 / 5	1,2528	1,837	48	84	1800 x 1160	1840 x 1200
180 / 6	1,4904	2,186	54	93	1800 x 1380	1840 x 1420
180 / 7	1,7280	2,534	60	102	1800 x 1600	1840 x 1640
180 / 8	1,9656	2,883	66	111	1800 x 1820	1840 x 1860
180 / 9	2,2399	3,231	72	120	1800 x 2040	1840 x 2080
180 / 10	2,4814	3,580	78	129	1800 x 2260	1840 x 2300
180 / 11	2,7230	3,928	84	138	1800 x 2480	1840 x 2520
180 / 12	2,9160	4,277	90	147	1800 x 2700	1840 x 2740
180 / 13	3,1536	4,625	96	156	1800 x 2920	1840 x 2960
240 / 4	1,3536	1,985	52	-	2400 x 940	2440 x 980
240 / 5	1,6704	2,450	59	-	2400 x 1160	2440 x 1200
240 / 6	1,9872	2,915	66	-	2400 x 1380	2440 x 1420
240 / 7	2,3424	3,379	73	-	2400 x 1600	2440 x 1640
240 / 8	2,6644	3,844	80	-	2400 x 1820	2440 x 1860
240 / 9	2,9865	4,308	87	-	2400 x 2040	2440 x 2080
240 / 10	3,3086	4,773	94	-	2400 x 2260	2440 x 2300
240 / 11	3,6307	5,238	101	-	2400 x 2480	2440 x 2520
240 / 12	3,8880	5,702	108	-	2400 x 2700	2440 x 2740
240 / 13	4,2048	6,167	115	-	2400 x 2920	2440 x 2960

other widths upon request

Parameter for DIN-version

Inclination of installation:

- up to 25° roof angle
(type SMOKEJET® D also in shed roof from 25°–90°)

Lamellar execution:

- 1-shelled aluminium lamellar uninsulated
- 2-shelled aluminium lamellar insulated
- PC 16 lamellar (in shed roof up to 45°)
- glass single-ply (LSG 3.3.1)

Operation:

- pneumatic cylinder (10bar) with spring reset and thermal activation unit in single pipe system according to DIN EN 12101-2
- pneumatic cylinder with locking and thermal activation unit in double pipe system according to DIN EN 12101-2
- 24 volt motor opener according to DIN EN 12101-2 (current between 1 and 5,2 ampere) (only special sizes upon request)

PLEASE CONTACT:

JET Tageslicht & RWA GmbH · Weidehorst 28 · D-32609 Hüllhorst
Tel. +49 (0) 57 44 / 503-0 · Fax +49 (0) 57 44 / 503-40



•ISO 9001 •BS OHSAS 18001
•installer SHEVS
•approved products

**DRIVEN BY
DAYLIGHT**